

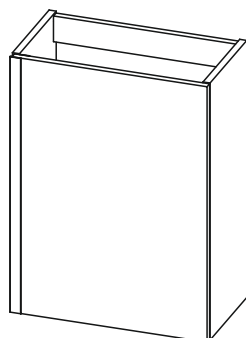

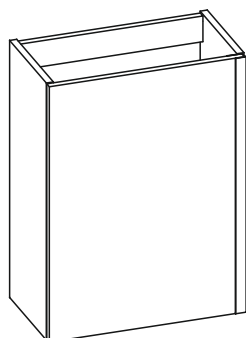

45 1D

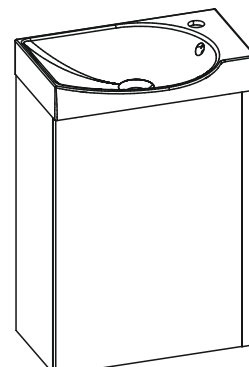
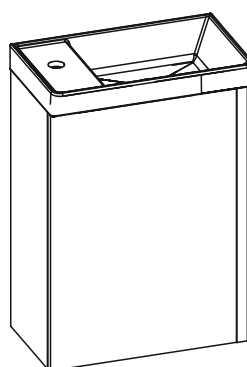
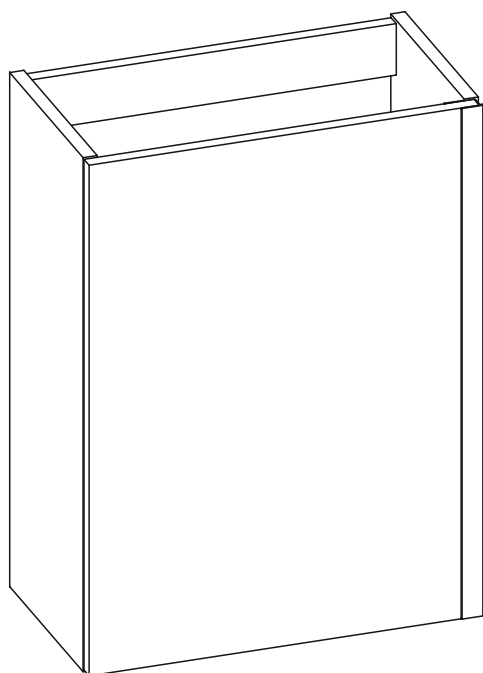

P0	D1	ZR2	R1
			
∅5 x 12	x 4	x 1 x 2	x 4

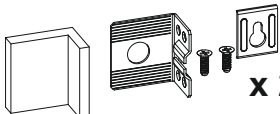

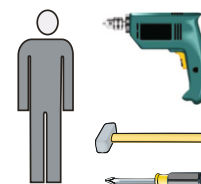
1

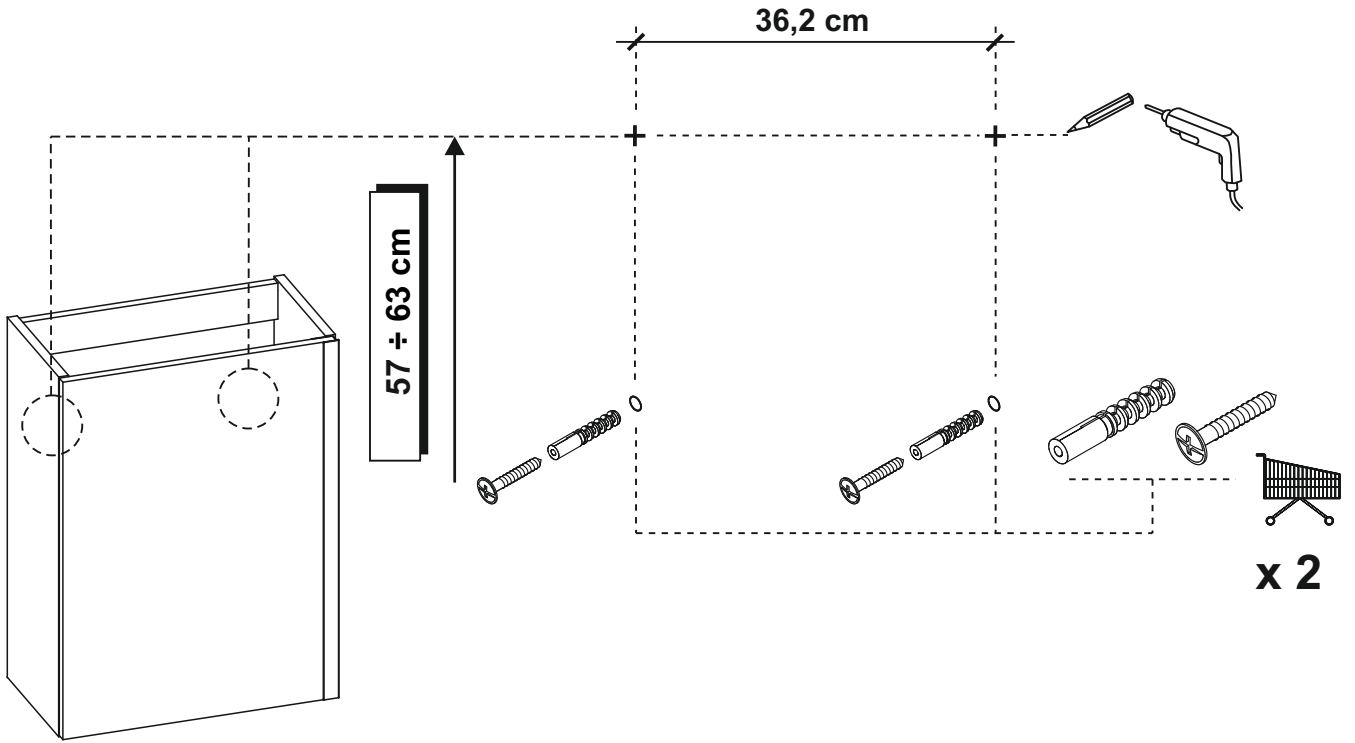

2

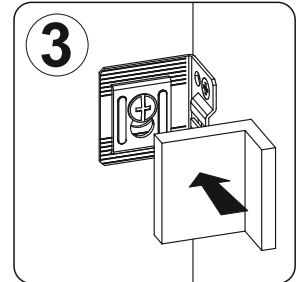
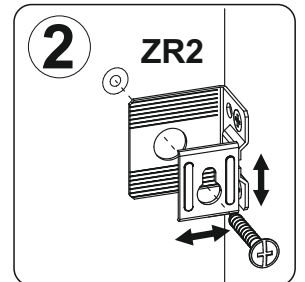
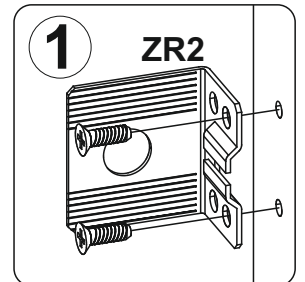
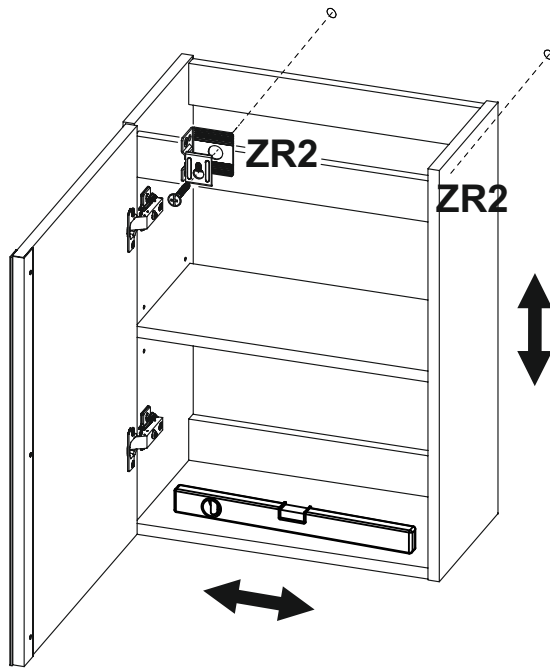

3

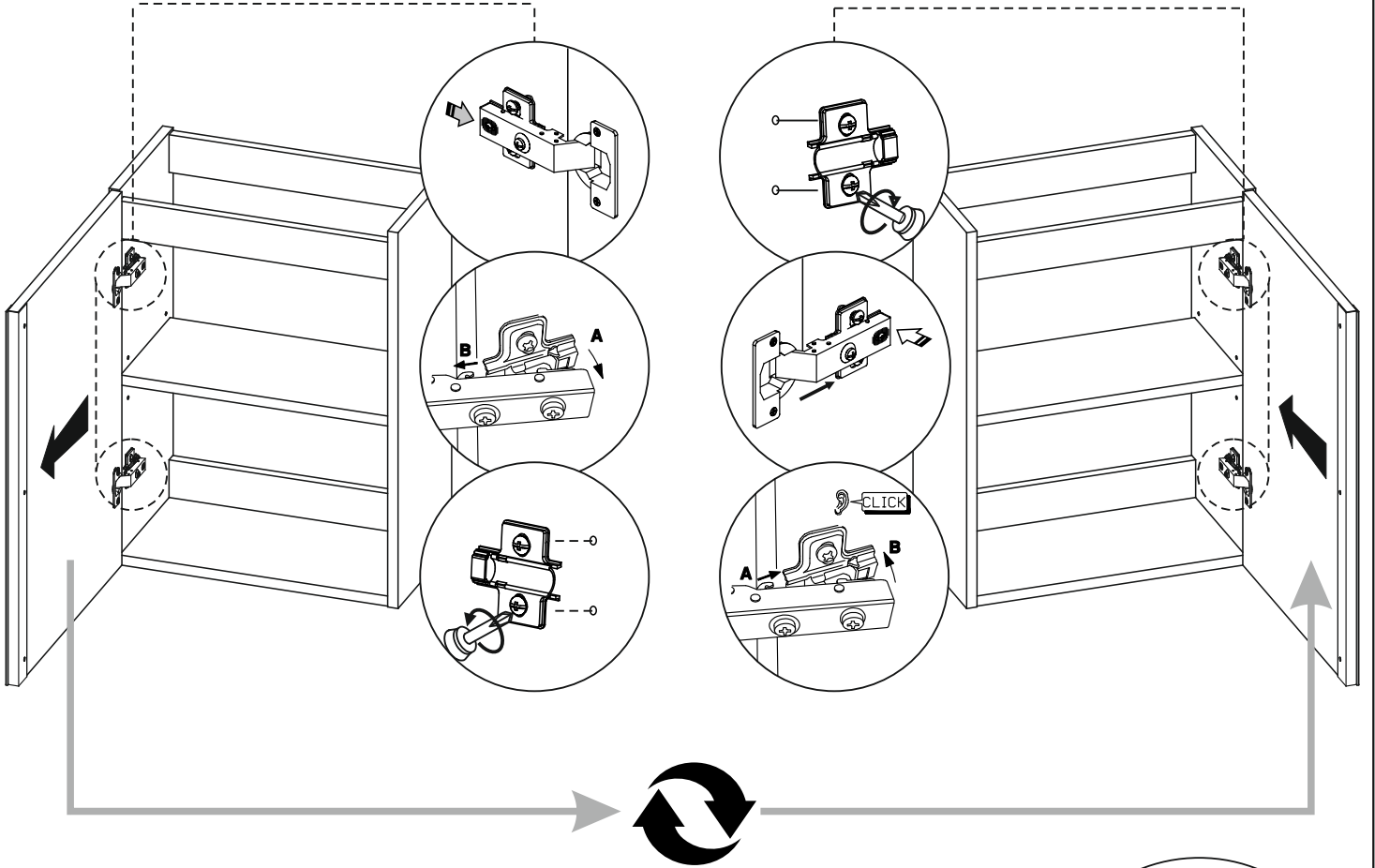

4

180°

